

temperature

JOFRA™

Wide temperature range

ATC-140 -20 to 140°C (-4 to 284°F)
ATC-250 28 to 250°C (82 to 482°F)

Liquid bath or dry-block

Use ATC-140 and ATC-250 as liquid bath or large diameter dry-block calibrator

Improved temperature homogeneity

Unique dual-zone block ensures good temperature homogeneity in the critical calibration zone

High accuracy

Using the internal reference or the external reference probe. 4-wire True-Ohm-Measurement technology is used

Enhanced stability

MVI circuitry ensures temperature stability despite mains supply variations

Cost effective calibration system

Stand-alone operation eliminates the need for secondary equipment and PC. Universal inputs handle multiple type temperature sensors

Timesaving features

Up- and download complete calibration tasks. Auto-stepping, switch testing and many more features make the daily use smooth and fast

Documentation made easy

RS232 communication and JOFRACAL calibration software are included in the standard delivery

Complete marine program

Part of a complete program of marine approved temperature, pressure and signal calibrators; including temperature sensors

ISO 9001 Manufacturer

Specification Sheet, SS-ATC140/250

INSTRUMENTS • CONTROLS • VALVES

ARCO
Engineering, Inc.
SINCE 1954
www.arcoengineering.com

3317 Gilmore Industrial Blvd.
Louisville, KY 40213
Ph: (502) 966-3134
Fx: (502) 966-3135

Advanced Temperature Calibrator Model ATC-140/250



The JOFRA ATC series (Advanced Temperature Calibrators) combines the accuracy of laboratory temperature sources with the speed and portability of field dry-block calibrators.

With the JOFRA ATC-140 and ATC-250 (Advanced Temperature Calibrators) it is possible to calibrate even more sensors at the same time and to calibrate large and odd size sensors in either a large diameter dry-block or in a liquid bath.

JOFRA ATC-140 and ATC-250 both features the unique dual-zone heating block - designed for optimum performance and superior temperature homogeneity throughout the block. This new design has a performance equivalent to a liquid temperature bath.

Each ATC dry-block calibrator may be used to perform fully automatic calibration routines without using an external computer. Use the computer for full upload and download capabilities. Units may also be supplied with inputs for external reference sensors and for sensors-under-test. All ATC calibrators feature RS232 serial communication and standard delivery also includes the JOFRACAL calibration PC software.

The ATC-140 and ATC-250 calibrators are part of a series of calibrators, that also includes the ATC-156, ATC-157, ATC-320 and ATC-650 dry-block calibrators covering temperature ranges between -45°C and 650°C.

AMETEK®
CALIBRATION INSTRUMENTS

Unique temperature performance

The ATC series of calibrators provide precision temperature calibration of sensors; whatever the type or format. This is accomplished through an innovative dual-zone heating technology.

Both the ATC-140 and ATC-250 feature a dual-zone heating technology. Each heating zone is independently controlled for precision temperature calibration. The homogeneity in the lower part is close to that of a laboratory liquid bath. The lower zone ensures optimum heat dissipation throughout the entire calibration zone. The upper zone compensates for heat loss from the sensor-under-test and from the open top. This design also eliminates the need for insulation of the sensors-under-test and makes it possible to calibrate liquid-filled and other mechanical sensors.

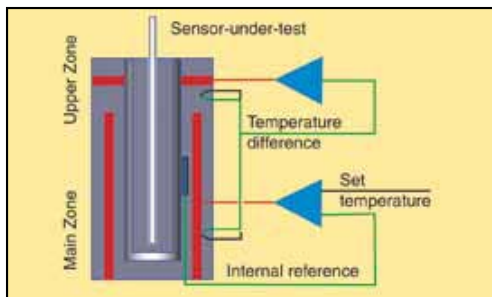

ATC heating and cooling models

The ATC-140 model with both heating and cooling capabilities feature the Peltier element multi-stage-technology. This both improves efficiency and extends the life of the »electronic heat pump«.

Peltier effect (ATC-140)

In 1834, Jean Peltier, a French physicist found that an »opposite thermocouple effect« could be observed when an electric current was connected to a thermocouple. Heat would be absorbed at one of the junctions and discharged at the other junction. This effect is called the »PELTIER EFFECT«.

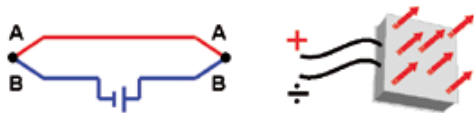

The practical Peltier element (electronic heating pump) consists of many elements of semiconductor material connected electrically in series and thermally in parallel. These thermoelectric elements and their electrical interconnections are mounted between two ceramic plates. The plates serve to mechanically hold the overall structure together and to electrically insulate the individual elements from one another.

MVI - Improved temperature stability

MVI stands for »Mains power Variance Immunity«.

Unstable mains power supplies are a major contributor to on-site calibration inaccuracies. Traditional temperature calibrators often become unstable in production environments where large electrical motors, heating elements, and other devices are periodically cycled on or off. The cycling of supply power can cause the temperature regulator to perform inconsistently leading to both inaccurate readings and unstable temperatures.

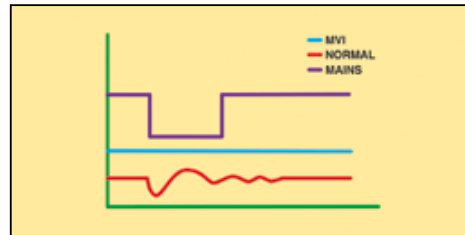

The JOFRA ATC-250 calibrator employ the MVI, thus avoiding such stability problems. The MVI circuitry continuously monitors the supply voltage and ensures a constant energy flow to the heating elements.

The ATC-140 models run on stabilized DC voltage and thus do not need the MVI circuitry.

Highest accuracy (model B only)

ATC series calibrators may be supplied with a built-in reference thermometer for use with an external probe. This feature allows one instrument to provide the freedom and flexibility to perform calibrations at the process site while maintaining a high accuracy.

A special 90° angled external reference sensor has been designed to accommodate sensors with a transmitter head, top connector or similar arrangement.

The user can decide whether to read the built-in reference sensor or the more accurate angled reference sensor from the calibrator's large, easy-to-read LCD display. The external sensor and the internal sensor are independent of one another. Downloading of reference sensor linearization is done via a personal computer.

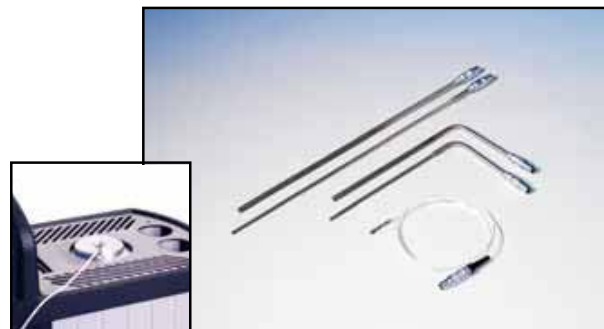

SET-Follows-TRUE (model B only)

Available on B models only, the “SET-Follows TRUE” makes the instrument tune in until the temperature of the external reference “TRUE” meets the desired “SET” temperature. This is used when it is critical that the temperature of the calibration zone matches the desired temperature when measured with accurate external reference sensors.

This feature is ideal when calibrating gas correctors or other custody transfer applications. It is also extremely useful to calculation procedures.

Reading of sensor-under-test (model B only)

The ATC series model B is equipped with built-in converters (inputs) that enables measurement of virtually any type of temperature sensor including:

- thermostats
- resistance thermometers (RTD)
- thermocouples (TC)
- transmitters
- milliamps (mA)
- voltage (V)

The ATC calibrators can be user-programmed for completely automated temperature calibrations. Once the unit is programmed, the instrument operates itself by performing the configured calibration routine. All calibration data is stored and available for uploading and generating exact calibration certificates or reports.

Switch test (model B only)

Users may perform a thermostatic test and find “Open”, “Closed” and the hysteresis (deadband) automatically. The instrument retains the last five tests.

Auto-stepping

Up to 20 different temperature steps may be programmed including the hold time for each step. Upon completion of an auto step routine, the user can easily read the results for the sensor-under-test. Up to five (5) auto step results are stored.

AUTO STEP SETUP			
 No. of steps: 5 Mode: One-way Hold time: 5 min	T ₁	0°C	T ₁₁ °C
	T ₂	100°C	T ₁₂ °C
	T ₃	200°C	T ₁₃ °C
	T ₄	300°C	T ₁₄ °C
	T ₅	400°C	T ₁₅ °C
	T ₆	°C	T ₁₆ °C
	T ₇	°C	T ₁₇ °C
	T ₈	°C	T ₁₈ °C
	T ₉	°C	T ₁₉ °C
	T ₁₀	°C	T ₂₀ °C
Back- + space		▲ Prev. field	▼ Next field

Easy-to-use, intuitive operation

All instrument settings can be performed from the front panel. The heat source is positioned away from the panel which helps protect the operator.

The ATC keyboard is equipped with five, positive feedback function keys. They correspond to the text in the display and change functionality based on instrument operations. There are also dedicated function keys with permanent functions.

The easy-to-read, backlit display is large with a high contrast that is readable even in high ambient light conditions. The display is easily read from all angles and from a distance without parallax problems. The display also features icons which help identifying instrument conditions and operational steps, making it more intuitive to work with.



Set temperature

The “Set temperature” feature allows the user to set the exact desired temperature with a resolution of 0.01°.

Enhanced stability

A stability indicator shows when the ATC calibrator has reached the desired temperature and is stable. The user may change the stability criteria, external reference and the sensor-under-test quickly and simply. The stability criteria is the user’s security for a correct calibration. A count-down timer is displayed next to the temperature read-out.

Instrument setups

The ATC series allows the user to store up to nine (9) complete instrument setups. You may store all sorts of information including temperature units, stability criteria, use of external reference sensor, resolution, sensor-under-test (SUT), conversion to temperature, display contrast, etc. The setup may be recalled at any time.

READ: 85.00°C ✓		SENSOR: 85.00°C		SET: 85.00°C	
SET temp.	Calibration	Switch test	Auto step	Setup	

Maximum temperature

From the setup menu, the user can select the maximum temperature limit for the calibrator. This function prevents damage to the sensor-under-test caused by the application of excessive temperatures. The feature also aids in reducing drift resulting from extended periods of exposures to high temperatures. This feature can be locked with an access code.

JOFRACAL CALIBRATION SOFTWARE

JOFRACAL calibration software ensures easy calibration of RTD's, thermocouples, transmitters, thermoswitches, pressure gauges and pressure switches. JOFRACAL can be used with JOFRA DPC-500, APC, CPC and IPI pressure calibrators, all JOFRA temperature calibrators, as well as JOFRA AMC900, ASC300 multi signal calibrator and ASM-800 signal multi scanner.



JOFRACAL calibration software may also be used for manual calibrations, as it can be set up to accept manual entry of calibration data together with other liquid baths, ice points or dry-block heat sources.

The calibration data collected may be stored on a PC for later recall or analysis. The ATC calibrator stores the calibration procedure and may be taken out to the process site without using a personal computer.

This allows the ATC calibrator to:

- Operate as a stand-alone instrument, using advanced calibration routines without the assistance of a personal computer on site;
- Prevent unauthorized changes to a calibration routine. Personnel who are not authorized to alter a calibration routine cannot do so.

Once all calibrations are completed, the data may be uploaded to the JOFRACAL calibration software for post-processing and printing of certificates. The calibration data collected may be stored on the personal computer for later recall or analysis.

The JOFRACAL temperature calibration software may be downloaded free of charge from our web-page www.jofra.com.



As found/as left (model B only)

The JOFRA ATC series calibrator automatically handles "As Found/As Left" calibrations. The calibrator stores both results. The first performed calibration is "As found" and the last performed calibration is the "As left", regardless of the number of calibrations/adjustments that may have been made in between.

SYNC output

An output is located directly on the front of the ATC calibrator. This output signals when the instrument is stable and may be used with ancillary devices such as video recorders, digital cameras or as an input to a data logging device. The SYNC output may be useful for automating and documenting your calibrations when calibrating external reading devices.

Calibration (model B only)

Users may perform or read the results of the calibration tasks directly on the instrument. When calibrating an indicating device, users may key in the results during or after the test. Using the "Calibration info" function, the user may view the complete calibration task, including the "Scenario" before the calibration takes place.

Calibration of up to 24 sensors with JOFRA ASM

Using the JOFRA ATC series together with the ASM Advanced Signal Multi-scanner offers a great time-saving automatic solution to calibrate multiple temperature sensors at the same time. The ASM series is an eight channel scanner controlled by the JOFRACAL software on a PC. Up to 3 ASM units can be stacked to calibrate up to 24 sensors at the same time. It can handle signals from 2-, 3- and 4 wire RTD's, TC's, transmitters, thermistors, temperature switches and voltage.

JOFRACAL software

Minimum hardware requirements for JOFRACAL calibration software.

- INTEL™ 486 processor
- (PENTIUM™ 800 MHz recommended)
- 32 MB RAM (64 MB recommended)
- 80 MB free disk space on hard disk prior to installation
- Standard VGA (800 x 600, 16 colors) compatible screen
- (1024 x 786, 256 colors recommended)
- CD-ROM drive for installation of the program
- 1 free RS232 serial port

FUNCTIONAL COMPARISON

ATC series		ATC-125 A	ATC-125 B	ATC-140 A	ATC-140 B	ATC-156 A	ATC-156 B	ATC-157 A	ATC-157 B	ATC-250 A	ATC-250 B	ATC-320 A	ATC-320 B	ATC-650 A	ATC-650 B
Temperature range @ ambient 23°C / 73°F															
-90 to 125°C	-130 to 257°F	X	X												
-20 to 140°C	-4 to 284°F			X	X										
-24 to 155°C	-11 to 311°F					X	X								
-45 to 155°C	-49 to 311°F							X	X						
28 to 250°C	82 to 482°F									X	X				
33 to 320°C	91 to 608°F											X	X		
33 to 650°C	91 to 1202°F													X	X
Temperature stability															
±0.01°C	±0.018°F					S	S	S	S			S	S		
±0.02°C	±0.036°F			X	X					X	X			S	S
±0.03°C	±0.054°F	X	X												
Accuracy incl. external STS reference sensor															
±0.04°C	±0.07°F			X ¹	X ¹	X ¹									
±0.06°C	±0.11°F	X	X												
±0.07°C	±0.13°F									X ¹	X ¹				
±0.11°C	±0.2°F													X ¹	
Accuracy with internal reference sensor															
±0.10°C	±0.18°F					S	S								
±0.13°C	±0.23°F							S	S						
±0.18°C	±0.32°F			S	S										
±0.20°C	±0.36°F											S	S		
±0.28°C	±0.50°F									S	S				
±0.30°C	±0.54°F	X	X												
±0.35°C	±0.63°F													S	S
Immersion depth															
185 mm	7.3 in	X	X												
180 mm	7.1 in			X ²	X ²										
160 mm	6.3 in					X	X	X	X						
150 mm	5.9 in			X ³	X ³					X ⁴	X	X	X	X	X
Insertion tube diameter															
63.5 mm	2.5 in			X	X					X	X				
30 mm	1.2 in	X	X			X	X					X	X	X	X
20 mm	0.8 in							X	X						

JOFRA ATC-156/157/320/650



For a wider product description of the ATC-156/157/320/650 please see spec. sheet SS-CP-2285, at www.jofra.com

JOFRA ATC-125



For a wider product description of the ATC-125 please see spec. sheet SS-CP-2282, at www.jofra.com

X = Delivered as standard

S = Improved specifications (from October 01, 2006)

- ¹ Using an external STS reference sensor connected to the reference probe input
- ² Immersion depth for ATC-140 as dry-block
- ³ Immersion depth for ATC-140 as liquid bath
- ⁴ Immersion depth for ATC-250 as dry-block and as liquid bath

	Model A	Model B
Dual-zone heating/cooling block	•	•
MVI - Mains Variance Immunity (or similar)	•	•
Stability indicator	•	•
Automatic step function	•	•
JOFRACAL Calibration software included as standard	•	•
SYNC output (for external recording device)	•	•
Display resolution 0.01°	•	•
Programmable max. temperature	•	•
Input for RTD, TC, V, mA		•
4-20 mA transmitter input incl. 24 VDC supply		•
All inputs scalable to temperature		•
Automatic switch test (open, close and hysteresis)		•
External precision reference probe input		•
Download of calibration work orders from PC		•
Upload of calibration results (as found & as left)		•
"SET" follows "TRUE"		•

Liquid bath / large diameter insert

The ATC-140 and ATC-250 are fitted with a 150 mm (5.9 in) deep well with a diameter of 63.5 mm (2.5 in) can be used both as dry-block calibrators and as liquid calibration baths with a magnetic stirrer.

A liquid bath and a dry-block diameter of 63.5 mm (2.5 in), which is twice the size of any other JOFRA dry-block, are both new in the JOFRA product range. With these options it is now possible to calibrate even more temperature sensors at the same time and to calibrate large as well as odd sizes and shapes of sensors, which is not possible to calibrate in the remaining product range.

ATC-140 & ATC-250 can be used without an external reference sensor, but if a STS-100 reference sensor is connected directly to a B version or the JOFRA reference thermometer DTI-1000, you obtain better accuracies and thereby use the full potential of the calibrators.



Why ATC-140 and ATC-250?

Calibration of many sensors at the same time due to more space for example in connection with validation of many thermocouples, which saves time

- Calibration of as many as 24 sensors at the same time by using 3 JOFRA ASM Signal Multi-Scanners
- For customers, who only want to use liquid baths
- For calibration of odd sizes and shapes of sensors
WET = no need for inserts, which fit the sensors
DRY = more space for calibration of special sensors
- The Pharmaceutical industry often wants to calibrate more sensors at the same time and often has many short sensors
- The Food industry often has odd sizes and shapes of sensors including sanitary ones
- The JOFRACAL software and the ATC B-models on-line can handle the calibration and documentation of multiple sensors calibrated at the same time. However, you need to change the input connection manually one-by-one

Liquid bath versus dry-block kit

The basic advantages of the liquid bath configuration versus the dry-block configuration are as follows:

- You do not need insertion tubes for all your different types of sensors
- You can calibrate sensors, which do not fit into insertion tubes
- You can calibrate glass thermometers and gas or liquid filled sensors
- The basic advantages of the dry-block configuration versus the liquid bath configuration are the following:
 - No hazardous hot liquids
 - Easier to handle insertion tubes than liquids
 - More convenient to carry than when filled with liquid
 - No need for external exhaustion

All specifications given in the liquid bath configuration are based on the silicone oil supplied and recommended by JOFRA.



CONFIGURATIONS

Liquid bath kit for ATC-140 A/B and ATC-250 A/B

- 1 x Sensor basket
- 2 x Covering lids
- 1 x Magnet – for the magnetic stirrer
- 1 x Magnet remover
- 1 x Liquid drainage tube
- 1 x Silicone oil 0,75 l (25.4 oz)



It is also possible to order extra silicone oil and a support rod for sensors, which can be mounted on the side of all JOFRA dry-block calibrators and hold the sensors under test in the correct position during calibration.



The support rod is especially important, when working with liquid baths and do not have the inserts to hold the sensors under test.

Dry-block kit for the ATC-140 A/B and ATC-250 A/B

1 x Multi-hole insert - it is possible to choose between a metric and an imperial version:

The metric version has holes for the following sizes of sensors: 1 x 12, 1 x 11, 1 x 9, 1 x 8, 2 x 6, 1 x 5, 2 x 4, 1 x 3 mm and 1 x 1/4 in.

The imperial version has holes for the following sizes of sensors: 1 x 1/8 in, 1 x 3/16 in, 1 x 1/4 in, 1 x 5/16 in, 1 x 3/8 in, 1 x 7/16 in, 1 x 1/2 in, 1 x 9/16 in, 1 x 5/8 in and 1 x 4 mm.

1 x Insulation plug for the ATC-140.

It is also possible to order undrilled and special drilled inserts.



PHYSICAL SPECIFICATIONS

Instrument dimensions (L x W x H)

All models 352 x 156 x 360 mm / 13.9 x 6.1 x 14.2 in

Instrument weight

ATC-140 12.8 kg / 28.2 lb
 ATC-250 10.8 kg / 23.8 lb

Insert dimensions

ATC-140/250 outer diameter 63.5 / 2.5 in
 ATC-140/250 inner diameter 57.5 mm / 2.26 in
 ATC-140/250 length 160 mm / 6.30 in

Weight of non-drilled insert (approximate)

ATC-140 1200 g / 42.3 oz
 ATC-250 1200 g / 42.3 oz

Shipping (including optional carrying case)

ATC-140 * 23.4 kg / 51.6 lb
 ATC-250 * 21.3 kg / 47.0 lb

Size: L x W x H.. 670 x 309 x 514 mm / 26 x 12.2 x 20.2 in

Shipping (without carrying case)

ATC-140 * 16.7 kg / 36.8 lb
 ATC-250 * 14.6 kg / 32.2 lb

Size: L x W x H. 570 x 235 x 440 mm / 22.4 x 9.3 x 17.3 in

Shipping (carrying case only)

Weight: 6.0 kg / 13.2 lb

Size: L x W x H.. 670 x 309 x 514 mm / 26 x 12.2 x 20.2 in

Miscellaneous

Serial data interface RS232 (9-pin male)
 Operating temperature 0 to 40°C / 32 to 104°F
 Storage temperature -20 to 50°C / -4 to 122°F
 Humidity 0 to 90% RH
 Protection class IP-10
 DNV Marine Approval, Certificate no A-10384

*If a dry-block or liquid bath kit is ordered, there will be an extra collie of approximately 2 kg (4.4 lb).

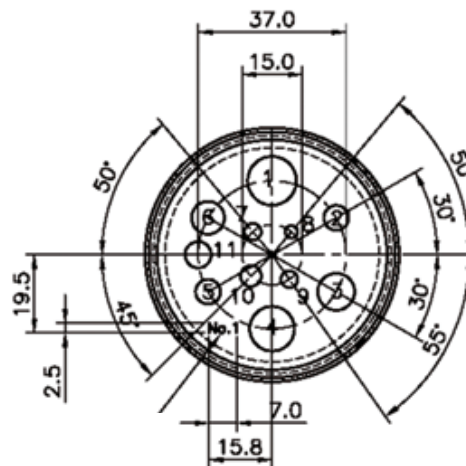

FUNCTIONAL SPECIFICATIONS

Mains specifications

ATC-140/250 115V(90-127) / 230V(180-254)
 Frequency, non US deliveries 50 Hz \pm 5, 60 Hz \pm 5
 Frequency, US deliveries 60 Hz \pm 5
 Power consumption (max.) ATC-140 300 VA
 Power consumption (max.) ATC-250 1150 VA

Temperature range

ATC-140 Maximum (Dry block) 140°C / 284°F
 Minimum @ ambient temp. 0°C / 32°F -35°C / -31°F
 Minimum @ ambient temp. 23°C / 73°F -20°C / -4°F
 Minimum @ ambient temp. 40°C / 104°F -5°C / 23°F

ATC-140 Maximum (Liquid bath) 140°C / 284°F
 Minimum @ ambient temp. 0°C / 32°F -33°C / -27°F
 Minimum @ ambient temp. 23°C / 73°F -18°C / 0°F
 Minimum @ ambient temp. 40°C / 104°F -3°C / 27°F

ATC-250 (Dry block) 28 to 250°C / 82 to 482°F
 ATC-250 (Liquid bath) 28 to 250°C / 82 to 482°F

Stability

ATC-140/250 +0.02°C / +0.04°F
 Measured after the stability indicator has been on for 15 minutes.
 Measuring time is 30 minutes.

Time to stability (approximate)

ATC-140/250 15 minutes

Accuracy (model B) with external STS reference sensor

ATC-140 +0.04°C / +0.07°F
 ATC-250 +0.07°C / +0.13°F
 12 month period. Relative to reference standard. Specifications by use of the external JOFRA STS-100 reference sensor (see specification sheet SS-CP-2290, which can be found at www.jofra.com)

Accuracy (model A+B) with internal reference sensor

ATC-140 A+B +0.18°C / +0.32°F 1) 2)
 ATC-250 A+B +0.28°C / +0.50°F 1) 3)
 12 month period. Specifications by use of the internal reference sensor.

- 1) Improved specifications (from October 1, 2006)
 - 2) When used with the dry-block kit. When used with the liquid bath kit the standard accuracy is \pm 0.30°C (0.54°F).
 - 3) When used with the dry-block kit. When used with the liquid bath kit the standard accuracy is \pm 0.50°C (0.90°F).
- Better accuracy with the liquid kits is obtainable, if a special calibration and adjustment are done with liquid.

Resolution (user-selectable)

All temperatures 1° or 0.1° or 0.01°

Radial homogeneity (difference between holes)

ATC-140/250 (dry-block) 0.05°C / 0.09°F
 ATC-140/250 (liquid bath) 0.025°C / 0.045°F

Immersion depth

ATC-140 (dry-block) 180 mm / 7.1 in
 ATC-140/250 (liquid bath) 150 mm / 5.9 in
 ATC-250 (dry-block) 150 mm / 5.9 in

Well diameter

ATC-140 63.8 / 2.51 in
 ATC-250 63.8 / 2.51 in

Heating time

ATC-140 -20 to 23°C / -4 to 73°F 10 minutes
 23 to 100°C / 73 to 212°F 31 minutes
 100 to 140°C / 212 to 284°F 23 minutes
 ATC-250 50 to 250°C / 122 to 482°F 11 minutes

Cooling time

ATC-140 140 to 100°C / 284 to 212°F 7 minutes
 100 to 23°C / 212 to 73°F 27 minutes
 23 to 0°C / 73 to 32°F 17 minutes
 0 to -15°C / 32 to 5°F 35 minutes
 ATC-250 250 to 100°C / 482 to 212°F 27 minutes
 100 to 50°C / 212 to 122°F 27 minutes

SYNC output (dry contact)

Switching voltage Maximum 30 VDC
 Switching current Maximum 100 mA

INPUT SPEC'S (B MODELS ONLY)

All input specifications apply to the calibrator's dry-block running at the respective temperature (stable plus an additional 20 minutes period). Where the input measuring range is out of the calibrator's range, the SET temperature is either MIN. or MAX.

Transmitter supply

Output voltage 24VDC \pm 10%
 Output current Maximum 25 mA

Transmitter input mA

Range 0 to 24 mA
 Accuracy (12 months) +0.01% Rdg. +0.015% F.S.

Voltage input VDC

Range: 0 to 12 VDC
 Accuracy (12 months) +0.005% Rdg. +0.015% F.S.

Switch input

Switch dry contacts
 Test voltage Maximum 5 VDC
 Test current Maximum 2.5 mA

RTD reference input (B models only)

Type 4-wire RTD with true ohm measurements¹⁾
 F.S. (Full Scale) 350 ohm
 Accuracy (12 months) \pm 0.001% rdg. + 0.002% F.S.

RTD Type	Temperature		12 months	
	°C	°F	°C	°F
Pt100 reference	-50	-58	\pm 0.020	\pm 0.036
	0	32	\pm 0.021	\pm 0.038
	155	311	\pm 0.023	\pm 0.041
	320	608	\pm 0.026	\pm 0.047
	650	1202	\pm 0.032	\pm 0.058
	700	1292	\pm 0.034	\pm 0.061

Note 1: True ohm measurements are an effective method to eliminate errors from induced thermoelectrical voltages

RTD input

Type of RTD 2-wire
 F.S. (range)..... 350 ohm or 2900 ohm
 Accuracy (12 months)
 $\pm(0.005\% \text{ rdg.} + 0.005\% \text{ F.S.} + 50 \text{ m}\Omega)$
 Type of RTD 3- or 4-wire
 F.S. (range)..... 350 ohm or 2900 ohm
 Accuracy (12 months) $\pm(0.005\% \text{ rdg.} + 0.005\% \text{ F.S.})$

RTD Type	Temperature		12 months	
	°C	°F	°C	°F
Pt1000	-50	-58	± 0.046	± 0.083
	0	32	± 0.050	± 0.090
	155	311	± 0.061	± 0.110
	320	608	± 0.071	± 0.127
Pt500	-50	-58	± 0.083	± 0.149
	0	32	± 0.087	± 0.157
	155	311	± 0.100	± 0.180
	320	608	± 0.111	± 0.200
Pt100	-50	-58	± 0.054	± 0.097
	0	32	± 0.058	± 0.104
	155	311	± 0.069	± 0.124
	320	608	± 0.079	± 0.142
Pt50 (only in Russian versions)	-50	-58	± 0.098	± 0.176
	0	32	± 0.103	± 0.185
	155	311	± 0.116	± 0.209
	320	608	± 0.128	± 0.230
Pt10	-50	-58	± 0.453	± 0.815
	0	32	± 0.462	± 0.831
	155	311	± 0.495	± 0.891
	320	608	± 0.524	± 0.943
Cu100	-50	-58	± 0.050	± 0.090
	0	32	± 0.052	± 0.094
	150	302	± 0.060	± 0.108
Cu50	-50	-58	± 0.090	± 0.162
	0	32	± 0.093	± 0.167
	150	302	± 0.100	± 0.180

If automatic cold junction compensation is used, the specification for CJ is $\pm 0.40^\circ\text{C}$ ($\pm 0.72^\circ\text{F}$).

Thermocouple input

Range 78 mV
 F.S. (Full Scale) 78 mV
 Accuracy (12 months) $\pm(0.01\% \text{ rdg.} + 0.005\% \text{ F.S.})$

TC Type	Temperature		12 months	
	°C	°F	°C	°F
E	-50	-58	± 0.08	± 0.14
	0	32	± 0.07	± 0.12
	155	311	± 0.07	± 0.12
	320	608	± 0.08	± 0.14
	650	1202	± 0.11	± 0.20
J	-50	-58	± 0.10	± 0.17
	0	32	± 0.08	± 0.14
	155	311	± 0.08	± 0.15
	320	608	± 0.10	± 0.18
	650	1202	± 0.12	± 0.22
K	-50	-58	± 0.11	± 0.20
	0	32	± 0.10	± 0.18
	155	311	± 0.11	± 0.20
	320	608	± 0.12	± 0.22
T	-50	-58	± 0.12	± 0.22
	0	32	± 0.10	± 0.18
	155	311	± 0.09	± 0.16
	320	608	± 0.09	± 0.17
R	-50	-58	± 1.31	± 2.35
	0	32	± 0.78	± 1.40
	155	311	± 0.50	± 0.90
	320	608	± 0.42	± 0.75
S	-50	-58	± 0.98	± 1.77
	0	32	± 0.78	± 1.40
	155	311	± 0.50	± 0.90
	320	608	± 0.46	± 0.83
B	-50	-58	± 0.45	± 0.81
	650	1202	± 0.45	± 0.81
	1768	3214	± 0.52	± 0.94
	250	482	± 1.57	± 2.83
N	-50	-58	± 0.99	± 1.78
	320	608	± 0.69	± 1.23
	1820	3308	± 0.48	± 0.86
	650	1202	± 0.16	± 0.29
XK (only in Russian versions)	-50	-58	± 0.16	± 0.29
	0	32	± 0.15	± 0.27
	155	311	± 0.14	± 0.24
	320	608	± 0.14	± 0.25
U	-50	-58	± 0.16	± 0.28
	800	1472	± 0.17	± 0.31
	650	1202	± 0.11	± 0.19
	800	1472	± 0.12	± 0.22
	-50	-58	± 0.07	± 0.13
	0	32	± 0.06	± 0.11
	155	311	± 0.06	± 0.12
	320	608	± 0.07	± 0.13
	-50	-58	± 0.12	± 0.21
	0	32	± 0.10	± 0.18
	155	311	± 0.09	± 0.17
	320	608	± 0.09	± 0.17
	600	1112	± 0.10	± 0.19

STANDARD DELIVERY

- ATC dry-block calibrator (user specified)
- Mains power cable (user specified)
- Traceable certificate - temperature performance
- Insert (user specified)
- Tool for insertion tubes
- RS232 cable
- JOFRACAL calibration software
- AMETRIM-ATC software to adjust the ATC series
- User manual
- Reference manual (English)

Model B instruments contain the following extra items:

- Test cables (2 x red, 2 x black)
- Traceable certificate - input performance
- Model ATC-140/250 instruments contain either a kit for liquid bath use OR a kit for dry-block use as standard

Liquid bath kit

The liquid bath kit for ATC-140 and ATC-250 contains a sensor basket, 2 covering lids, a magnet and a magnetic remover, a liquid drainage tube and 0.75 l silicone oil.



Kit - liquid bath - ATC-140 A/B: 125022

Kit - liquid bath - ATC-250 A/B: 125035

Dry-block kit

The dry-block kit for ATC-140 and ATC-250 contains a multihole insert .

The dry-block kit for the ATC-140 also contains a matching insulation plug.



Kit - dry-block - ATC-140 A/B - metric: 125023

Kit - dry-block - ATC-140 A/B - inch: 125024

Kit - dry-block - ATC-250 A/B - metric: 125025

Kit - dry-block - ATC-250 A/B - inch: 125026

ACCESSORIES

- 125066 Extra fixture for sensor grib
- 125067 Extra sensor grib
- 122771 Mini-Jack Connector for stable relay Output
- 120516 Thermocouple Male Plug - Type J - Black
- 120517 Thermocouple Male Plug - Type K - Yellow
- 120514 Thermocouple Male Plug - Type N - Orange
- 120515 Thermocouple Male Plug - Type T - Blue
- 120518 Thermocouple Male Plug - Type R / S - Green
- 120519 Thermocouple Male Plug - Type Cu-Cu - White
- 122801 Cable 0.5 m with LEMO / LEMO connectors
- 122823 2 m Cable Female Banana to LEMO connection
- 125002 Edge port Converter with 4 pcs of RS232 ports
- 124878 Sensor basket
- 124880 Covering lid for transportation/calibration
- 124883 Stirring magnet
- 124886 Stirring magnet remover
- 125126 Liquid drainage tube
- 125033 Silicone Oil, Type 200/10cSt, 0.75L for ATC-140

Heat shield (Optional) - 105496

An external heat shield may be placed on top of the calibrator to reduce the hot air stream around the sensor-under-test. This is especially important for testing thermocouples having head-mounted transmitters with cold-junction compensation.



Carrying case (Optional) - 105805

The optional protective carrying case ensures safe transportation and storage of the instrument and all associated equipment.



Trolley (Optional) - 124315

A removable trolley for ATC carrying case 105805 ensures easy and safe transportation of the instrument.



Support rod set (Optional) - 125068

Support rod for sensors to be mounted on all JOFRA dry-block calibrators. Holds the sensor under test in their position, while calibrating. Includes 2 sensors grips and 2 fixtures for sensor grips.



UNDRILLED INSERTS FOR ATC-140 AND ATC-250

Inserts, undrilled		
Inserts	Instruments	
	ATC-140 A/B	ATC-250 A/B
One undrilled insert	124899	124891
Insulation plug	124895	N/A

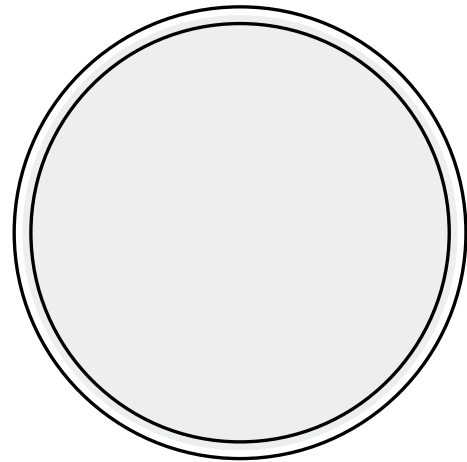

1:1

MULTI-HOLE INSERTS FOR ATC-140 AND ATC-250 - METRIC (MM)

Spare part no. for multi-hole inserts - metric (mm)		
Insert code ¹	Instruments	
	ATC-140 A/B	ATC-250 A/B
M01	124897	124889

Note: All inserts (metric and inches) for ATC-140 are supplied with a matching insulation plug.

Note 1: Use the insert code, when ordered as the standard insert together with a new calibrator.

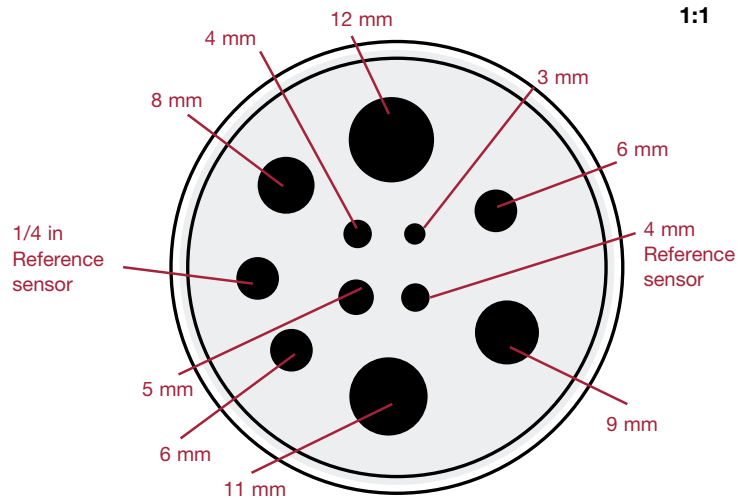

1:1

MULTI-HOLE INSERTS FOR ATC-140 AND ATC-250 - IMPERIAL (INCH)

Spare part no. for multi-hole inserts - imperial (inch)		
Insert code ¹	Instruments	
	ATC-140 A/B	ATC-250 A/B
M02	124898	124890

Note: All inserts (metric and inches) for ATC-140 are supplied with a matching insulation plug.

Note 1: Use the insert code, when ordered as the standard insert together with a new calibrator.

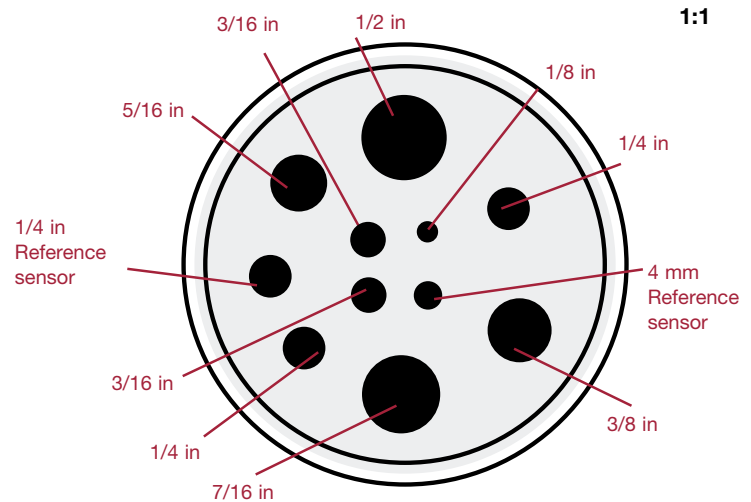

1:1

ORDERING INFORMATION

Order number	Description
ATC140	ATC-140 series, -20 to 140°C (-4 to 284°F)
ATC250	ATC-250 series, 28 to 250°C (82 to 482°F)
Model version	
A	Basic model no sensor-under-test or reference probe input
B	Including sensor-under-test and reference probe input
Power supply (US deliveries 60 Hz only)	
115	115VAC
230	230VAC
Mains power cable type	
A	European, 230V,
B	USA/CANADA, 115V
C	UK, 240V
D	South Africa, 220V
E	Italy, 220V
F	Australia, 240V
G	Denmark, 230V
H	Switzerland, 220V
I	Israel, 230V
Insert type and size	
XXX	1 x Insert for dry-block configuration (please see the previous insert pages for the right insert codes)
BAT	Liquid bath
Calibration certificate	
F	NPL Traceable temperature certificate (standard for Europe, Asia, Australia and Africa)
G	NIST traceable temperature certificate (standard for Americas)
H	Accredited certificate
Options	
C	Carrying case
M	Additional liquid kit, if dry-block configuration is ordered above
R	90° angled reference probe with accredited certificate (STS100A901AH)
X	No option used

ATC140B230AM01FX **Sample order number**
 JOFRA ATC-140 B with standard accessories, 230VAC, European power cord, dry-block configuration with multihole insert type M01, and NPL traceable temperature certificate.



AMETEK Calibration Instruments

is one of the world's leading manufacturers and developers of calibration instruments for temperature, pressure and process signals as well as for temperature sensors both from a commercial and a technological point of view.

JOFRA Temperature Instruments

Portable precision thermometers. Dry-block and liquid bath calibrators: 5 series, with more than 25 models and temperature ranges from -90° to 1205°C / -130° to 2200°F. All featuring speed, portability, accuracy and advanced documenting functions with JOFRACAL calibration software.

JOFRA Pressure Instruments

Convenient electronic systems ranging from -25 mbar to 1000 bar (0.4 to 15,000 psi) - multiple choices of pressure ranges, pumps and accuracies, fully temperature-compensated for problem-free and accurate field use.

JOFRA Signal Instruments

Process signal measurement and simulation for easy control loop calibration and measurement tasks - from handheld field instruments to laboratory reference level bench top instruments.

JOFRA / JF Marine Instruments

A complete range of calibration equipment for temperature, pressure and signal, approved for marine use.

FP Temperature Sensors

A complete range of temperature sensors for industrial and marine use.

M&G Pressure Testers

Pneumatic floating-ball or hydraulic piston dead weight testers with accuracies to 0.015% of reading.

M&G Pumps

Pressure generators from small pneumatic "bicycle" style pumps to hydraulic pumps generating up to 1,000 bar (15,000 psi).

*...because calibration is
a matter of confidence*



AMETEK Denmark A/S
 Gydevang 32-34 | 3450 Allerød | Denmark
 T: +45 4816 8000 | ametek@ametek.dk

Sales & Service:
 Europe, Asia, Africa, Middle East and South America

Information in this document is subject to change without notice. ©2009, by AMETEK, Inc., www.ametek.com. All rights reserved.

AMETEK Mansfield & Green (North America)
 T: +1 800 527 9999 | cal.info@ametek.com

AMETEK Singapore Pte. Ltd. (Singapore)
 T: +65 6 484 2388 | aspl@ametek.com.sg

AMETEK Inc. Beijing Rep. Office (China)
 T: +86 10 8526 2111 | jofra@ametek.com.cn

AMETEK GmbH (Germany)
 T: +49 2159 9136 510 | info.mct-de@ametek.de

AMETEK Calibration Instruments (UK)
 T: +44 (0) 1243 833 302 | jofra@ametek.co.uk

www.jofra.com