

**INSTRUMENTS • CONTROLS • VALVES**

CLICK TO VISIT OUR WEBSITE

**ARCO** Engineering, Inc. **3317 Gilmore Industrial Blvd.**  
 Louisville, KY 40213

SINCE 1954 Ph: (502) 966-3134  
 www.arcoengineering.com Fx: (502) 966-3135

**100 Series**



**BUY ONLINE**

**100 Series**

**PRESSURE, VACUUM, DIFFERENTIAL PRESSURE AND TEMPERATURE SWITCHES**



**FEATURES**

- Single Switch Output
- Epoxy Coated and Gasketed Cast Aluminum Enclosure Type 4X
- Tamper-Resistant Set Point "Lock"
- Heat Trace and Freeze Protection Thermostats
- Proof Pressures to 10,000 psi (689,5 bar)
- Adjustable Ranges:

Pressure:  
 30 "Hg Vac to 5000 psi  
 (-1 to 344,7 bar)

"wc Ranges:  
 300 "wc Vacuum to 250 "wc Pressure  
 (-746,7 to 622,3 mbar)

Differential Pressure:  
 0.2 "wcd to 500 psid  
 (0,5 mbar to 34,5 bar)

Temperature:  
 -180 to 650°F  
 (-117.8 to 343.3°C)



## OVERVIEW

The 100 Series is a cost-effective pressure and temperature switch for process plants and OEM equipment. The rugged, one piece enclosure features a slanted cover for wiring accessibility.

A wide variety of microswitch and process-connection options make this versatile series ideal for applications requiring a rugged weather-proof mechanical switch.

Typical applications that utilize the 100 Series are heat tracing, freeze protection, processing equipment (pumps, compressors), inputs for annunciator panels, and fire suppression systems.

## FEATURES

- UL listed and cUL certified.
- CE compliant to low voltage directive and pressure equipment directive.
- Optional ATEX or GOST intrinsic safety compliance
- Single switch (SPDT or DPDT) output
- Welded stainless steel diaphragm models
- Ultra low pressure, "wc models
- Optional sensor material for corrosive media
- Polished stainless steel flush-mount connection
- Pump switch models with wide adjustable deadband



## SPECIFICATIONS

<b>STORAGE TEMPERATURE</b>	-65 to 160°F (-54 to 71°C)
<b>AMBIENT TEMPERATURE LIMITS</b>	-40 to 160°F (-40 to 71°C); models 520-525, 540-548, 700-706, 15731-15736: 0 to 160°F (-18 to 71°C); Set point typically shifts less than 1% of range for a 50°F (28°C) ambient temperature change
<b>SET POINT REPEATABILITY</b>	Temperature models: ± 1% of adjustable range Pressure models 15623, 15731-15737, 171-174, 218, 270-376, 520-535, 540-543, 700-706, 560-564: ± 1% of adjustable range; models 190-194, 183-189, 483-494, 544-548, 565-567, 610-680, 15884: ±1.5% of adjustable range Internal set point lock on all pressure models
<b>SHOCK</b>	Set point repeats after 15 G, 10 millisecond duration
<b>VIBRATION</b>	Set point repeats after 2.5 G, 5-500 Hz
<b>ENCLOSURE</b>	Die cast aluminum, epoxy powder coated, gasketed, captive cover screws
<b>ENCLOSURE CLASSIFICATION</b>	Enclosure type 4X
<b>SWITCH OUTPUT</b>	One SPDT snap action switch; switch may be wired "normally open" or "normally closed"
<b>ELECTRICAL RATING</b>	15A 125/250/480 VAC resistive except for H100-15623, 15731-15737, 15884, 20A 125/250/480 VAC resistive, B100-13546 and E100-13545, 22A/480 VAC. Electrical switches have limited DC capabilities at 24-30 VDC, 2A resistive and 1A inductive. 125 VDC, 0.5A resistive, 0.03A inductive. Consult factory for additional information.
<b>WEIGHT</b>	2-7 lbs; Varies with model
<b>ELECTRICAL CONNECTION</b>	1/2" NPT (female); Two 7/8" diameter knockouts
<b>PRESSURE CONNECTION</b>	Models 15623, 218, 270-376, 610-680, 701-706, 15731-15884: 1/4" NPT (female); Models 171-194, 483-494, 520-535, 15737: 1/2" NPT (female); Models 540-548: 1/8" NPT (female); Models 560-564: 2" Sanitary Fitting; Models 565-567: 1.5" Sanitary Fitting (Sanitary fittings mate with Tri-Clamp® fitting systems)
<b>TEMPERATURE ASSEMBLY</b>	Bulb and capillary: 6 feet 304 stainless steel except for E100-13545, 10 feet 304 stainless steel Immersion stem: nickel-plated brass (standard) except for B100-13546 stainless steel; optional 316L stainless steel
<b>FILL</b>	Models 1BS/BC are solvent filled, models 2-8 non-toxic oil filled
<b>TEMPERATURE DEADBAND</b>	Type <b>F</b> typically 1% and type <b>B, C,</b> and <b>E</b> typically 2% of range under laboratory conditions (70°F ambient circulating bath at rate of 1/2°F per minute change)
<b>HEAT TRACING OR FREEZE PROTECTION</b>	Thermostats designed specifically for heat tracing and freeze protection ambient sensing applications are available with types B100 and E100

## APPROVALS

UE declarations and third-party issued Agency certifications are available for download at [www.ueonline.com/prod\\_approval](http://www.ueonline.com/prod_approval).



### **UNITED STATES AND CANADA**

**UL** Listed, **cUL** Certified

Temperature: UL 873; CSA C22.2 no. 24, File # E10667

Pressure: UL 508; CSA C22.2 no. 14, File # E42272;

Enclosure Type 4X



### **EUROPE**

**ATEX Directive (94/9/EC)**



II 1 G EEx ia IIC T6, **(OPTIONAL - code M405)**

Tamb.= -50°C to +60°C

UL International DEMKO A/S (N.B.#0539)

Certificate #DEMKO 03 ATEX 0335063

EN 50014, 50020, 50284

**Low Voltage Directive (LVD) (73/23/EC & 93/68/EEC)**

UEC compliant to LVD

Products rated lower than 50 VAC and 75 VDC are outside of the scope of the LVD

**Pressure Equipment Directive (PED) (97/23/EC)**

Compliant to PED

Products rated lower than 7.5 psi are outside the scope of the PED



### **RUSSIA**

Gosgortekhnadzor Permit **(OPTIONAL - code M406)**

0ExiaIIC T6

Tamb = -50°C to +60°C

NANIO CCVE Certification Center

Certificate # ROSS US.GB05.Bo2933

GOST R 51330.0, 51330.1, 51330.10 & 51330.14

## PRESSURE MODEL CHART

Model	Adjustable Set Point Range		Deadband		Over Range Pressure*		Proof Pressure**					
	Low end of range on fall; High end of range on rise											
	"wc	mbar	"wc	mbar	psi	bar	psi	bar				
<b>Type H100</b>												
Buna N diaphragm and O-Ring with epoxy coated aluminum 1/2" NPT (female) pressure connection, large 0.72" orifice for clean-out purposes (other wetted materials available see page 11)												
520	300 Vac to 0	-746,7 to 0	0.2 to 8	0,5 to 19,9	200	13,8	400	27,6				
521	10 Vac to 10	-24,9 to 24,9	0.1 to 0.6	0,2 to 1,5	200	13,8	400	27,6				
522	50 Vac to 50	-124,5 to 124,5	0.1 to 3	0,2 to 7,5	200	13,8	400	27,6				
523	0.5 to 5.0	1,2 to 12,4	0.1 to 0.3	0,2 to 0,7	200	13,8	400	27,6				
524	2.5 to 50	6,2 to 124,5	0.1 to 0.8	0,2 to 2,0	200	13,8	400	27,6				
525	10 to 250	24,9 to 622,3	0.1 to 6	0,2 to 14,9	200	13,8	400	27,6				
Welded 316L stainless steel diaphragm and 1/2" NPT (female) pressure connection, large 0.72" orifice for clean-out purposes												
530	300 Vac to 0	-746,7 to 0	0.2 to 15	0,5 to 37,3	50	3,4	100	6,9				
531	10 Vac to 10	-24,9 to 24,9	0.1 to 0.6	0,2 to 1,5	50	3,4	100	6,9				
532	50 Vac to 50	-124,5 to 124,5	0.1 to 3	0,2 to 7,5	50	3,4	100	6,9				
533	0.5 to 5.0	1,2 to 12,4	0.1 to 0.3	0,2 to 0,7	50	3,4	100	6,9				
534	2.5 to 50	6,2 to 124,5	0.1 to 0.8	0,2 to 2,0	50	3,4	100	6,9				
535	10 to 250	24,9 to 622,3	0.1 to 10	0,2 to 24,9	50	3,4	100	6,9				
Model	Adjustable Set Point Range		Adjustable Deadband			Over Range Pressure*		Proof Pressure**				
	Low End		Mid Range		High Range							
	"wc	mbar	"wc	mbar	"wc	mbar	psi	bar	psi	bar		
Buna N diaphragm and O-Ring with epoxy coated aluminum, 1/2" NPT (female) pressure connection, large 0.72" orifice for clean-out purposes; includes adjustable deadband microswitch												
15737	50 Vac to 50	-124,5 to 124,5	0.5 to 7	1,2 to 17,4	1 to 10	2,5 to 24,9	2 to 13	5,0 to 32,4	200	13,8	400	27,6
Deadband												
			psi	bar (unless noted)	psi	mbar	psi	bar	psi	bar		
Welded 316L stainless steel diaphragm and 1/2" NPT (female) pressure connection, large 0.72" orifice for clean-out purposes (NACE MR-0175 compliant)												
171	1 to 20	68,9 mbar to 1,4	0.1 to 1	6,9 to 68,9	500	34,5	1000	68,9				
172	2 to 50	0,1 to 3,4	0.1 to 1.5	6,9 to 103,4	500	34,5	1000	68,9				
173	4 to 100	0,3 6,9	0.1 to 2.5	6,9 to 172,4	500	34,5	1000	68,9				
174	8 to 200	0,6 to 13,8	0.1 to 3.5	6,9 to 241,3	500	34,5	1000	68,9				
2" sanitary welded 316L stainless steel diaphragm and pressure connection. Mates with Tri-Clamp® fitting systems (not UE supplied)												
560	0.5 to 15	34,5 mbar to 1.0	0.1 to 1	6,9 to 68,9	200	13,8	300	20,7				
561	1 to 25	68,9 mbar to 1,7	0.1 to 1.5	6,9 to 103,4	200	13,8	300	20,7				
562	2 to 50	0,1 to 3,4	0.1 to 2.5	6,9 to 172,4	200	13,8	300	20,7				
563	4 to 100	0,3 6,9	0.1 to 4	6,9 to 275,8	200	13,8	300	20,7				
564	8 to 200	0,6 to 13,8	0.1 to 5	6,9 to 344,7	200	13,8	300	20,7				

Tri-Clamp® is a registered trademark of Alfa Laval.

**Application Note:** The use of metallic diaphragms where higher pressure shock or heavy cycling is expected should be avoided. Models 171-174 should not be used where system or start-up vacuum pressure might exceed 26" Hg Vac (-0.9 bar).

\* **Over Range Pressure:** The maximum pressure that may be applied continuously without causing damage and maintaining set point repeatability.

\*\* **Proof Pressure:** The maximum pressure to which a pressure sensor may be occasionally subjected, which causes no permanent damage. The unit may require calibration (e.g., start-up, testing).



## PRESSURE MODEL CHART

Model	Adjustable Set Point Range		Deadband		Over Range Pressure*		Proof Pressure**	
	psi	bar (unless noted)	psi	bar (unless noted)	psi	bar	psi	bar

**Type H100**

1.5" sanitary welded 316L stainless steel diaphragm and pressure connection. Mates with Tri-Clamp® fitting systems (not UE supplied)

565	5 to 30	0,3 to 2,1	1 to 5	68,9 mbar to 0,3	1000	68,9	1500	103,4
566	10 to 100	0,7 to 6,9	1 to 12	68,9 mbar to 0,8	1000	68,9	1500	103,4
567	15 to 300	1,0 to 20,7	3 to 22	0,2 to 1,5	1000	68,9	1500	103,4

Buna-N diaphragm and O-ring with nickel-plated brass 1/4" NPT (female) pressure connection; Option M540 Viton® diaphragm and O-ring available for models 701-705

701	1.5 to 30	103,4 mbar to 2,1	1 to 2	68,9 mbar to 0,1	500	34,5	600	41,4
702	3 to 100	0,2 to 6,9	1 to 4	68,9 mbar to 0,3	500	34,5	600	41,4
703	9 to 300	0,6 to 20,7	1 to 5	68,0 mbar to 0,3	500	34,5	600	41,4
704	15 to 500	1,0 to 34,5	2 to 8	0,1 to 0,6	1500	103,4	2500	172,4
705	30 to 1000	2,1 to 68,9	3 to 20	0,2 to 1,4	1500	103,4	2500	172,4
706	100 to 1700	6,9 to 117,2	10 to 30	0,7 to 2,1	2000	103,4	2500	172,4

Viton® diaphragm and O-Ring with 316 stainless steel 1/4" NPT (female) pressure connection (includes adjustable deadband switch)

15623	20 to 200	1,4 to 13,8	12 to 26	0,8 to 1,8	500	34,5	1000	68,9
-------	-----------	-------------	----------	------------	-----	------	------	------

Model	Adjustable Set Point Range		Adjustable Deadband			Over Range Pressure*		Proof Pressure**	
	psi	bar	Low End psi	Mid Range psi	High End psi	psi	bar	psi	bar

Buna N diaphragm and O-Ring nickel-plated brass 1/4" NPT (female) pressure connection; includes adjustable deadband microswitch

15731	3 to 30	0,2 to 2,1	1.5 to 4	0,1 to 0,3	2 to 4.5	0,1 to 0,3	2.5 to 5	0,2 to 0,3	500	34,5	600	41,4
15732	5 to 100	0,3 to 6,9	3 to 6	0,2 to 0,4	4 to 7.5	0,3 to 0,5	5 to 9	0,3 to 0,6	500	34,5	600	41,4
15733	9 to 300	0,6 to 27,0	4 to 11	0,3 to 0,8	5 to 13	0,3 to 0,9	5 to 16	0,3 to 1,1	500	34,5	600	41,4
15734	15 to 500	1,0 to 34,5	8 to 25	0,6 to 1,7	9 to 28	0,6 to 1,9	10 to 31	0,7 to 2,1	1500	103,4	2500	172,4
15735	30 to 1000	2,1 to 68,9	9 to 30	0,6 to 2,1	10 to 35	0,7 to 2,4	30 to 90	2,1 to 6,2	1500	103,4	2500	172,4
15736	100 to 1700	6,9 to 117,2	25 to 60	1,7 to 4,1	40 to 80	2,8 to 5,5	50 to 100	3,4 to 6,9	2000	137,9	2500	172,4

Model	Adjustable Set Point Range		Deadband		Over Range Pressure*		Proof Pressure**	
	psi	bar	Lower 75% range span psi	Top 25% range span bar	psi	bar	psi	bar

Welded 316 stainless steel diaphragm and 1/2" NPT (female) pressure connection, large 0.72" orifice for clean-out purposes (NACE MR-0175 compliant)

190	5 to 30	0,3 to 2,1	1 to 3	0,1 to 0,2	6 max	0,4	1500	103,4	2500	172,4
191	10 to 100	0,7 to 6,9	1 to 8	0,1 to 0,6	15 max	1,0	1500	103,4	2500	172,4
192	15 to 300	1,0 to 20,7	3 to 18	0,2 to 1,2	25 max	1,7	1500	103,4	2500	172,4
193	20 to 500	1,4 to 34,5	4 to 30	0,3 to 2,1	45 max	3,1	1500	103,4	2500	172,4
194	80 to 1700	5,5 to 117,2	5 to 120	0,3 to 8,3	150 max	10,3	2000	137,9	2500	172,4

**Application Note:** The use of metallic diaphragms where higher pressure shock or heavy cycling is expected should be avoided. Models 171-174 should not be used where system or start-up vacuum pressure might exceed 26" Hg Vac (-0.9 bar).

Model	Adjustable Set Point Range		Deadband		Over Range Pressure*		Proof Pressure**		
	Low end of range on fall; psi	High end of range on rise bar	Lower 75% range span psi	Top 25% range span bar	psi	bar	psi	bar	
<b>Type H100</b>									
Welded 316 stainless steel diaphragm and 1/2" NPT (female) pressure connection, 0.06" orifice to dampen pulsations									
490	5 to 30	0,3 to 2,1	1 to 3	0,1 to 0,2	6 max	0,4	1500	103,4	2500 172,4
491	10 to 100	0,7 to 6,9	1 to 8	0,1 to 0,6	15 max	1,0	1500	103,4	2500 172,4
492	15 to 300	1,0 to 20,7	3 to 18	0,2 to 1,2	25 max	1,7	1500	103,4	2500 172,4
493	20 to 500	1,4 to 34,5	4 to 30	0,3 to 2,1	45 max	3,1	1500	103,4	2500 172,4
494	80 to 1700	5,5 to 117,2	5 to 120	0,3 to 8,3	150 max	10,3	2000	137,9	2500 172,4
	psi (unless noted)	bar	psi (unless noted)	bar (unless noted)	psi	bar	psi	bar	
316L stainless steel diaphragm (optional Hastelloy® C or Monel®); Viton® GLT O-Ring (optional Kalrez®, Ethylene Propylene, or Aflas®); 316 stainless steel 1/2" NPT (female) pressure connection (optional Hastelloy® C or Monel®), large 0.72" orifice for clean-out purposes. Models 188 and 189 have a 316L stainless steel 1/2" NPT (female) pressure connection (NACE MR-0175 compliant)									
183	1 to 20	0,1 to 1,4	0.3 to 2.5	20,7 to 172,4 mbar	500	34,5	1000	68,9	
184	2 to 50	0,1 to 3,4	0.3 to 3	20,7 to 206,8 mbar	500	34,5	1000	68,9	
185	4 to 100	0,3 to 6,9	0.5 to 6	34,5 to 413,7 mbar	500	34,5	1000	68,9	
186	8 to 200	0,6 to 13,8	1 to 11	0,1 to 0,8	500	34,5	1000	68,9	
188	50 to 1000	3,4 to 68,9	25 to 125	1,7 to 8,6	2000	137,9	7000	482,6	
189	250 to 3500	17,2 to 241,3	50 to 300	3,4 to 20,7	4000	275,8	7000	482,6	
316L stainless steel diaphragm (optional Hastelloy® C or Monel®); Viton® GLT O-Ring (optional Kalrez®, ethylene propylene or Aflas®); 316 stainless steel 1/2" NPT (female) pressure connection (optional Hastelloy® C or Monel®), 0.06" orifice to dampen pulsations. Models 488 and 489 316L stainless steel pressure connection (NACE MR-0175 compliant)									
483	1 to 20	0,1 to 1,4	0.3 to 2.5	20,7 to 172,4 mbar	500	34,5	1000	68,9	
484	2 to 50	0,1 to 3,4	0.3 to 3	20,7 to 206,8 mbar	500	34,5	1000	68,9	
485	4 to 100	0,3 to 6,9	0.5 to 6	34,5 to 413,7 mbar	500	34,5	1000	68,9	
486	8 to 200	0,6 to 13,8	1 to 11	0,1 to 0,8	500	34,5	1000	68,9	
488	50 to 1000	3,4 to 68,9	25 to 125	1,7 to 8,6	2000	137,9	7000	482,6	
489	250 to 3500	17,2 to 241,3	50 to 300	3,4 to 20,7	4000	275,8	7000	482,6	
Phosphor bronze bellows with nickel-plated brass 1/4" NPT (female) pressure connection. Model 218 has 300 series stainless steel spring exposed to media									
218	30 "Hg Vac to 0	-1 to 0	1 to 2 "Hg	33,9 to 67,7 mbar	3	0,2	30	2,1	
270	4 to 200	0,3 to 13,8	1 to 8	0,1 to 0,6	200	13,8	250	17,2	
274	6 to 300	0,4 to 20,7	1 to 10	0,1 to 0,7	300	20,7	350	24,1	
Welded 316L stainless steel bellows and 1/4" NPT (female) pressure connection									
358	15 to 200	1,0 to 13,8	1 to 6	0,1 to 0,2	200	13,8	800	55,2	
361	20 to 300	1,4 to 20,7	1 to 7	0,1 to 0,3	300	20,7	800	55,2	
376	25 to 500	1,7 to 34,5	1.5 to 8	0,1 to 0,3	500	34,5	800	55,2	

Hastelloy® is a registered trademark of Haynes International, Inc. Monel® is a registered trademark of The Special Metals Corporation. Viton® and Kalrez® are registered trademarks of E.I. duPont de Nemours and Company. Aflas® is a registered trademark of Asahi Glass.

\* Over Range Pressure: The maximum pressure that may be applied continuously without causing damage and maintaining set point repeatability.

\*\* Proof Pressure: The maximum pressure to which a pressure sensor may be occasionally subjected, which causes no permanent damage. The unit may require calibration (e.g., start-up, testing).

**Deadband Note:** Models 190-194, 490-494 are expressed as the lower 75% and top 25% of the range span because of the operating characteristics of the diaphragm sensor and switch. Use of optional diaphragm materials for models 483-489 may increase deadband.



## PRESSURE MODEL CHART

Model	Adjustable Set Point Range		Deadband		Over Range Pressure*		Proof Pressure**	
	psi	bar	psi	bar	psi	bar	psi	bar
<b>Type H100</b>								
303 stainless steel piston, Buna N O-Ring with 303 stainless steel 1/4" NPT (female) pressure connection								
610	75 to 1000	5,2 to 68,9	30 to 150	2,1 to 10,3	6000	413,7	10,000	689,5
612	125 to 3000	8,6 to 206,8	40 to 250	2,8 to 17,2	6000	413,7	10,000	689,5
616	700 to 5000	48,3 to 344,7	40 to 375	2,8 to 25,9	6000	413,7	10,000	689,5
	psi	bar	psi	bar	psi	bar	psi	bar
303 stainless steel piston, Buna N O-Ring with 303 stainless steel 1/4" NPT (female) pressure connection (includes adjustable deadband switch)								
15884	700 to 5000	48,3 to 344,7	80 to 500	5,5 to 34,5	6000	413,7	10,000	689,5
316 stainless steel bellows and 1/4" NPT (female) pressure connection (Not recommended for rapid or high cycling pressure changes)								
680	100 to 1700	6,9 to 117,2	9 to 40	0,6 to 2,8	1700	117,2	2500	172,4

## DIFFERENTIAL PRESSURE MODEL CHART

Model	Adjustable Set Point Range		Deadband		Working Pressure***		Proof Pressure**	
	psid	bar	psi	bar	psi	bar	psi	bar
<b>Type H100K</b>								
(unless noted) (unless noted) (unless noted) (unless noted) (unless noted)								
Buna N diaphragm and sealing diaphragms with epoxy coated aluminum 1/8" NPT (female) pressure connections								
540	0.2 to 7 "wcd	0,5 to 17,4 mbar	0.05 to 0.6 "wc	0,1 to 1,5 mbar	30 "Hg Vac to 200	-1 to 13,8	400	27,6
541	1 to 20 "wcd	2,5 to 49,8 mbar	0.1 to 1.0 "wc	0,2 to 2,5 mbar	30 "Hg Vac to 200	-1 to 13,8	400	27,6
542	5 to 50 "wcd	12,4 to 124,5 mbar	0.2 to 2.5 "wc	0,5 to 6,2 mbar	30 "Hg Vac to 200	-1 to 13,8	400	27,6
543	10 to 200 "wcd	24,9 to 497,8 mbar	0.5 to 8 "wc	1,2 to 19,9 mbar	30 "Hg Vac to 200	-1 to 13,8	400	27,6
544	2 to 20	0,1 to 1,4	0.1 to 1.3	6,9 to 89,6 mbar	30 "Hg Vac to 1200	-1 to 82,7	2500	172,4
545	5 to 50	0,3 to 3,4	0.2 to 2.2	13,8 mbar to 0,1	30 "Hg Vac to 1200	-1 to 82,7	2500	172,4
546	10 to 125	0,7 to 8,6	0.4 to 5.0	27,6 mbar to 0,3	30 "Hg Vac to 1200	-1 to 82,7	2500	172,4
547	50 to 250	3,4 to 17,2	0.8 to 10	0,1 to 0,7	30 "Hg Vac to 1200	-1 to 82,7	2500	172,4
548	100 to 500	6,9 to 34,5	2.0 to 15	0,1 to 1,0	30 "Hg Vac to 1200	-1 to 82,7	2500	172,4

\* Over Range Pressure: The maximum pressure that may be applied continuously without causing damage and maintaining set point repeatability.

\*\* Proof Pressure: The maximum pressure to which a pressure sensor may be occasionally subjected, which causes no permanent damage. The unit may require calibration (e.g. start-up, testing).

\*\*\*Working Pressure Range: The pressure range within which two opposing sensors can be safely operated and still maintain set point adjustability.



## TEMPERATURE MODEL CHART

Model	Adjustable Set Point Range		Max. Temp		Scale Division		Stem or Bulb Size†/Finish‡‡
	°F	°C	°F	°C	°F	°C	
<b>Type B100</b> Internal adjustment via reference dial <b>Type C100</b> No reference dial; model 13546 not available							
120	0 to 225	-17.8 to 107.2	275	135	10†	5†	9/16" x 1-7/8" below 1/2 "NPT thread (nickel-plated brass)
121	200 to 425	93.3 to 218.3	475	246.1	10†	5†	9/16" x 1-7/8" below 1/2 "NPT thread (nickel-plated brass)
13546†	15 to 140	-9.4 to 60	160	71.1	5†	2†	9/16" x 2-11/16" long stainless steel (Freeze Protection)
<b>Type E100</b> Stainless steel bulb and capillary; internal adjustment via reference dial							
2BSA	-120 to 100	-84.4 to 37.8	150	65.6	10	5	3/8 x 2-5/8"
2BSB	30 to 250	-1.1 to 121.1	300	148.9	10	5	3/8 x 2-5/8"
3BS	100 to 400	37.8 to 204.4	450	232.2	10	5	3/8 x 2-1/8"
4BS	25 to 100	-3.9 to 37.8	150	65.6	2	1	3/8 x 6-3/4"
5BS	-20 to 80	-28.9 to 26.7	130	54.4	5	2	3/8 x 5"
8BS	350 to 640	176.7 to 337.8	690	365.6	10	5	3/8 x 3-1/4"
13545	25 to 325	-3.9 to 162.8	360	182.2	10	5	1/8 x 11-5/8" (Heat Tracing)
Copper bulb and capillary							
2BCA	-120 to 100	-84.4 to 37.8	150	65.6	10	5	3/8 x 2-5/8"
2BCB	30 to 250	-1.1 to 121.1	300	148.9	10	5	3/8 x 2-5/8"
3BC	100 to 400	37.8 to 204.4	450	232.2	10	5	3/8 x 2-1/8"
4BC	25 to 100	-3.9 to 37.8	150	65.6	2	1	3/8 x 6-3/4"
5BC	-20 to 80	-28.9 to 26.7	130	54.4	5	2	3/8 x 5"
8BC	350 to 640	176.7 to 337.8	690	365.6	10	5	3/8 x 3-1/4"
<b>Type F100</b> Stainless steel bulb and capillary; no reference dial							
1BS	-180 to 120	-117.8 to 48.9	170	76.7	N/A		3/8 x 3-3/4"
2BS	-125 to 350	-87.2 to 176.7	400	204.4	N/A		3/8 x 2-5/8"
3BS	-125 to 500	-87.2 to 260	550	287.8	N/A		3/8 x 2-1/8"
4BS	-40 to 120	-40 to 48.9	170	76.7	N/A		3/8 x 6-3/4"
5BS	-40 to 180	-40 to 82.2	230	110	N/A		3/8 x 5"
6BS	0 to 250	-17.8 to 121.1	300	148.9	N/A		3/8 x 4-1/2"
7BS	0 to 400	-17.8 to 204.4	450	232.2	N/A		3/8 x 3"
8BS	50 to 650	10 to 343.3	700	371.1	N/A		3/8 x 3-1/4"
Copper bulb and capillary							
1BC	-180 to 120	-117.8 to 48.9	170	76.7	N/A		3/8 x 3-3/4"
2BC	-125 to 350	-87.2 to 176.7	400	204.4	N/A		3/8 x 2-5/8"
3BC	-125 to 500	-87.2 to 260	550	287.8	N/A		3/8 x 2-1/8"
4BC	-40 to 120	-40 to 48.9	170	76.7	N/A		3/8 x 6-3/4"
5BC	-40 to 180	-40 to 82.2	230	110	N/A		3/8 x 5"
6BC	0 to 250	-17.8 to 121.1	300	148.9	N/A		3/8 x 4-1/2"
7BC	0 to 400	-17.8 to 204.4	450	232.2	N/A		3/8 x 3"
8BC	50 to 650	10 to 343.3	700	371.1	N/A		3/8 x 3-1/4"

†Type B100 only

‡Optional immersion stem lengths and capillary lengths are available. Standard capillary length is 6 ft except models 13545 which is 10 ft.

‡‡Optional stainless steel immersion stem, and armored capillary covering available.



## HOW TO ORDER

### BUILDING A PART NUMBER

#### Select a **Type**

Refer to the "Type" section below.

Determine type number based on switch output, enclosure, adjustment and reference.

Fill in the type portion of your part number with the corresponding number.

#### Select a **Model**

Refer to the "Model Charts".

Determine model based on adjustable range, deadband and proof pressure.

Fill in the model portion of your part number with the corresponding number.

#### Select an **Option**

Refer to the "Options" section.

Determine option number based on switch output, optional materials or other product enhancements.

Fill in the option portion of your part number with the corresponding number.

Leave "option" portion blank if no options are needed.

FOR MULTIPLE OPTIONS: Call United Electric Controls.

### TYPE

### DESCRIPTION

#### PRESSURE

Type H100 - One SPDT output; epoxy coated enclosure; internal adjustment with "High-Low" reference scale

#### DIFFERENTIAL PRESSURE

Type H100K - One SPDT output; epoxy coated enclosure; internal adjustment with "High-Low" reference scale

#### TEMPERATURE

Type B100 - Immersion stem; one SPDT output; internal adjustment with reference dial

Type C100 - Immersion stem; one SPDT output; internal adjustment with no reference

Type E100 - Bulb and capillary; one SPDT output; internal adjustment with reference dial

Type F100 - Bulb and capillary; one SPDT output; internal adjustment with no reference

#### SWITCH OPTIONS\*

0140	Gold contacts, 1A 125 VAC resistive. NOT AVAILABLE MODELS 13545, 13546, 15623, 15731-15884
0500	Close deadband, 5A 125/250 VAC resistive. NOT AVAILABLE MODELS 520-535, 13545, 13546, 15623, 15731-15884
1010	DPDT switch, 10A 125/250 VAC resistive; deadband and minimum set point will increase. NOT AVAILABLE TEMPERATURE VERSIONS, TYPE H100K OR MODELS 171-194, 483-567, 680, 15623, AND 15731-15884
1070	10 A 125 VDC resistive; deadband and minimum set point will increase. NOT AVAILABLE MODELS 171-194, 483-535, 560-567, 13545, 13546, 15623, 15731-15884
1519	Adjustable deadband, 15 A 125/250/480 VAC resistive; adjustment wheel changes rise setting only. If adjustment on fall setting is required, use primary adjustment. NOT AVAILABLE TYPES B100, E100 OR MODELS 171-194, 483-494, 560-567, 610-616, 51623, 15731-15884
1530	External manual reset, 15 A 125/250/480 VAC resistive; latches on rise, only. NOT AVAILABLE MODELS 13545, 13546, 15623, 15731-15884
1535	High ambient, 15 A 125/250 VAC resistive; temperatures up to 250°F (121.1°C). NOT AVAILABLE MODELS 520-535, 13545, 13546, 15623, 15731-15884
1537	Vapor sealed switch, 15 A 125/250 VAC resistive. NOT AVAILABLE MODELS 523, 533, 13545, 13546, 15623, 15731-15884
2000	20 A 125/250/480 VAC resistive. NOT AVAILABLE TYPE H100K OR MODELS 520-535, 13545, 13546, 15623, 15731-15884
3000	30 A 125/250/277 VAC resistive. NOT AVAILABLE TYPE H100K OR MODELS 171-194, 483-567, 680, 13545, 13546, 15623, 15731-15884

\* All switches have limited DC capabilities. Consult factory for details.

**OTHER OPTIONS**

M020	Red status light, 115 VAC only. NOT AVAILABLE MODELS 13545, 13546, 15623, 15731-15884
M201	Factory set one switch; specify increasing or decreasing pressure or temperature and setpoint
M277	Range indicated on nameplate in kPa or MPa, factory selected. NOT AVAILABLE ON TEMPERATURE VERSIONS
M278	Range indicated on nameplate in Kg/cm <sup>2</sup> . NOT AVAILABLE ON TEMPERATURE VERSIONS
M405	Intrinsic safety compliance for European Union per ATEX standards
M406	Intrinsic Safety compliance for Russia per Gosgortekhnadzor standards.
M444	Paper ID tag
M446	Stainless steel ID tag & wire attachment
M449	Surface mounting hardware kit that is required for models 520-535, 15737, & 540-548 when surface mounting. Use option code only at time of ordering product, otherwise use surface and pipe mounting kit part number 6361-704 as a separate order or for other models.
M504	316L stainless steel immersion stem. AVAILABLE TEMPERATURE MODELS 120, 121 ONLY
M540	Viton® construction (deadband and low end range may increase slightly); wetted parts include Viton® diaphragm and O-ring plus stainless steel pressure connection. AVAILABLE ON MODELS 610-616 (O-ring only), 701-705 (Viton diaphragm & O-ring, stainless steel pressure connection), AND 540-548 (Viton diaphragms and seals, pressure connections remain aluminum)
M550	Oxygen service cleaning; alcohol cleaning to remove residue from the process connection. NOT AVAILABLE ON PRESSURE MODEL 706
M914	1/2" NPT (female) stainless steel pressure connection. AVAILABLE MODELS 358-376, 610-616
M921	Brass pressure connection. AVAILABLE MODELS 610-616
6361-704	Surface and pipe mounting hardware kit for all models. Required for surface mounting models 520-535, 15737 & 540-548 if not previously ordered with option M449.
SD6286-51	Watertight conduit fitting; connects 7/8" hole to 1/2" NPT (female) fitting
<b>ALSO AVAILABLE:</b>	UE Final Inspection Reports, Certified Drawings, and other Certificates are available. Please consult your UE representative for additional information.

**OPTIONAL SENSOR MATERIAL FOR "WC RANGES. AVAILABLE MODELS 520-525**

XC001	Aluminum pressure connection, Viton® diaphragm, Viton® O-ring
XC002	Aluminum pressure connection, Kapton® diaphragm, Buna N O-ring
XC003	Aluminum pressure connection, Kapton® diaphragm, Viton® O-ring
XC004	316L Stainless steel pressure connection, 316L stainless steel diaphragm, Viton® O-ring. (Over range pressure is limited to 100 psi)
XC005	316L Stainless steel pressure connection, Viton® diaphragm, Viton® O-ring
XC007	316L Stainless steel pressure connection, Teflon® diaphragm, Viton® O-ring

**OPTIONAL SENSOR MATERIALS FOR CORROSIVE MEDIA. AVAILABLE MODELS 183-189, 483-489**

XD002	Hastelloy C diaphragm (NACE MR-0175 compliant)
XD003	Monel diaphragm (NACE MR-0175 compliant)
XP112	Hastelloy C pressure connection (NACE MR-0175 compliant)
XP113	Monel pressure connection (NACE MR-0175 compliant)
XR211	Kalrez® O-ring
XR213	Ethylene propylene O-ring
XR214	Aflas® O-ring

**OPTIONAL FLUSH MOUNT FLANGES. AVAILABLE MODELS 560-567**

F196	Flush mounted flange, 150#, 1" lap joint, raised face	AVAILABLE MODELS 565-567 ONLY
F197	Flush mounted flange, 150#, 2" lap joint, raised face	AVAILABLE MODELS 560-564 ONLY
F198	Flush mounted flange, 300#, 1" lap joint, raised face	AVAILABLE MODELS 565-567 ONLY
F199	Flush mounted flange, 300#, 2" lap joint, raised face	AVAILABLE MODELS 560-564 ONLY

**Note:** No options are available on Heat Trace and Freeze Protection models 13546 and 13545 or pump switch models 15623 & 15731-15737 except M201, M405, M406 M444, M446 and M550. No options are available on model 15884 except M201 & M446.



## OPTIONS FOR TEMPERATURE MODELS

### UNION CONNECTORS\*\*

Option	Replacement Number	Description
	<u>Brass</u>	
W027	SD6213-27	1/2" NPT w/ 3/4" bushing
W045	SD6213-45	3/4" NPT
W051	SD6213-51	1/2" NPT
	<u>304 Stainless Steel</u>	
W028	SD6213-28	1/2" NPT w/ 3/4" bushing
W046	SD6213-46	3/4" NPT
W050	SD6213-50	1/2" NPT

### THERMOWELLS\*\*

*For all bulb & capillary switches, except Model 13545*

Option	Replacement Number	Description
	<u>Brass</u>	
W075	SD6225-75	1/2" NPT with 3/4" NPT adapter bushing, 4" BT
W191	SD6225-191	1/2" NPT, 4" BT
W118	SD6225-118	1/2" NPT with 3/4" NPT adapter bushing, 7" BT
W192	SD6225-192	1/2" NPT, 7" BT
	<u>316 Stainless Steel</u>	
W076	SD6225-76	3/4" NPT, 4.5" BT
W193	SD6225-193	1/2" NPT, 4.5" BT
W119	SD6225-119	3/4" NPT, 7.5" BT
W177	SD6225-177	1/2" NPT, 7.5" BT

*For all immersion stem switches; except Model 13546*

W139	SD6225-139	3/4" NPT X 1-23/32" BT, BRASS
W140	SD6225-140	3/4" NPT X 1-23/32" BT, 316 ST/ST

### W000 IMMERSION STEM AND THERMOWELLS

**Note:** Option W000 is a special Immersion Stem construction that has no external thread. This option fits inside a special thermowell and is secured with a set-screw.

Option	Description
W000	Immersion stem only, brass
W097	Immersion stem and thermowell. Includes W000 stem and 1/2" NPT x 1-23/32" BT Brass thermowell
W099	Immersion stem and thermowell. Includes W000 stem and 1/2" NPT x 1-23/32" BT 316 ST/ST thermowell.

### OPTIONAL LENGTHS:

Optional immersion stem lengths to 15" may be available in Brass, with or without 316 ST/ST thermowell. Consult UE for additional information and availability. Optional capillary length to \*50' may be available in Copper or 304 ST/ST. Armor or Teflon® capillary protection may be available to lengths less than or equal to capillary length. Consult UE for additional information and availability.

\*Consult UE regarding repeatability and ambient effects on capillary lengths over 30'.  
\*\* Dimensional drawings for union connectors and thermowells may be found at [www.ueonline.com](http://www.ueonline.com)

**DIMENSIONAL DRAWINGS**

Dimensional drawings for all models may be found at [www.ueonline.com](http://www.ueonline.com)

Types B100, C100, E100, F100, H100, H100K

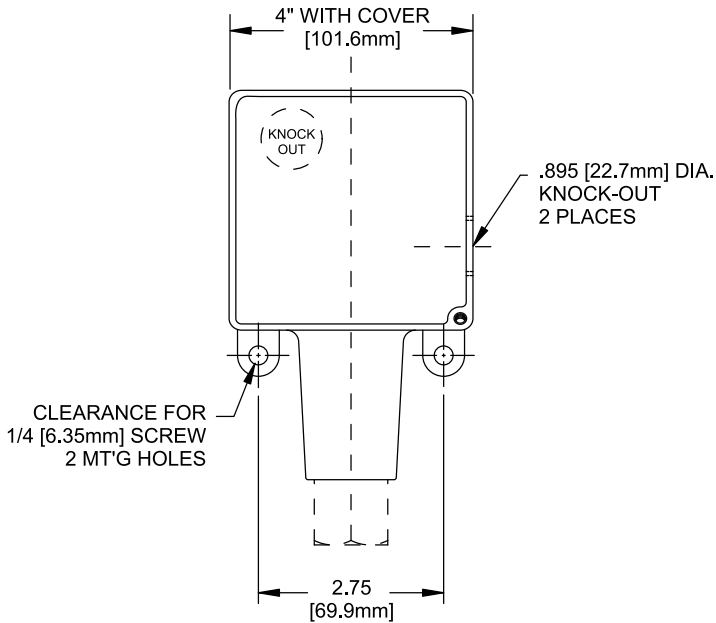
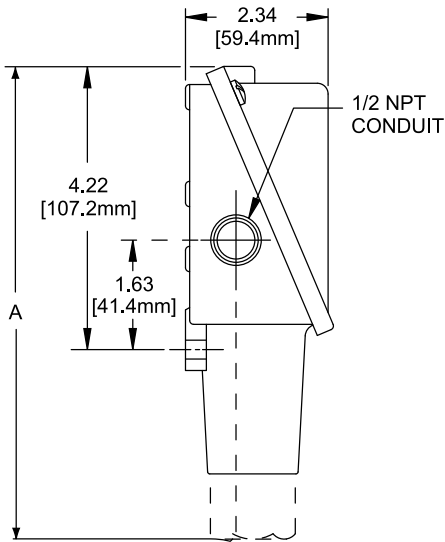

Dimension A			
Models	Inches	mm	NPT
<b>Pressure</b>			
171-174	7.63	193.8	1/2"
183-186, 484-486	7.56	192.0	1/2"
188-189, 488-489	6.63	168.4	1/2"
190-194, 490-494	6.63	168.4	1/2"
218	6.56	166.6	1/4"
270-274	7.00	177.8	1/4"
358-376	7.00	177.8	1/4"
520-525, 15737	8.44	214.4	1/2"
530-535	8.00	203.2	1/2"
560-564	6.63	168.4	2" Sanitary Fitting
565-567	6.63	168.4	1-1/2" Sanitary Fitting
610-616, 680, 15884	7.00	177.8	1/4"
701-706, 15623, 15731-15736	6.63	168.4	1/4"
<b>Differential Pressure</b>			
540-543	8.47	215.1	1/8"
544-548	8.53	216.7	1/8"
<b>Temperature</b>			
120, 121, 13546	9.38	238.3	Immersion stem
1BC-8BC, 1BS-8BS, 13545	8.69	220.7	Bulb & capillary

All dimensions stated in inches (millimeters)

## DIMENSIONAL DRAWINGS

Dimensional drawings for all models may be found at [www.ueonline.com](http://www.ueonline.com)

### Temperature Sensors

Models 1BC-8BC, 1BS-8BS, 13545

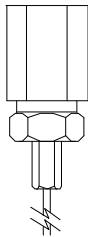

Models 120,121

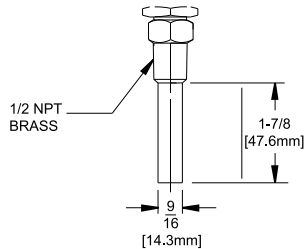

Model 13546

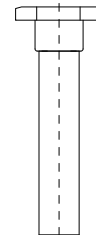

### Pressure Sensors

Models 171-174

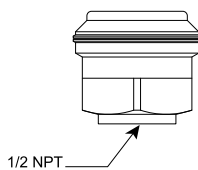

Models 183-186, 483-486

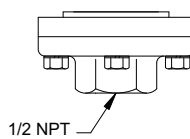

Models 188-194, 488-494

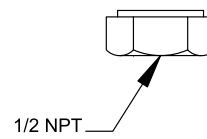

Models 218-376, 610-706, 15623, 15731-15736

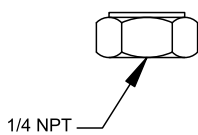

Models 520-525, 15737

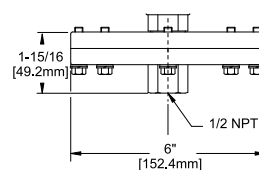

Models 530-535

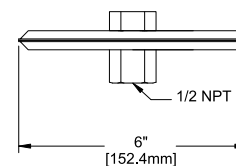

Models 540-543

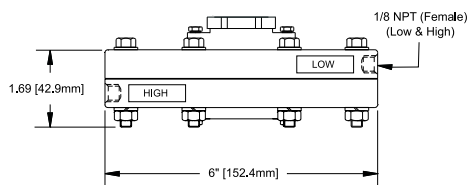

Models 544-548

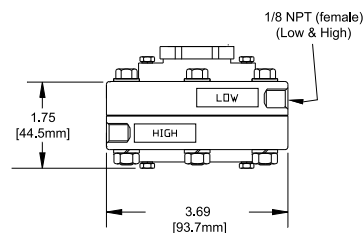

Models 560-564

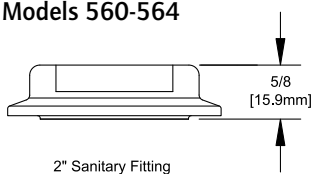

Models 565-567

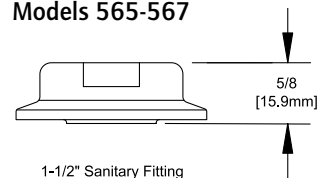

All dimensions stated in inches (millimeters)

ALTERNATIVE PRODUCTS FROM UE

**One Series**

- Electronic solid-state reliability
- Two-wire operation
- Digital display with keypad set-up
- 100% of range adjustable on-off deadband
- 4-20 mA output models
- Continuous diagnostic health check

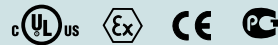

**10 Series**

- Compact, cylindrical enclosure
- Pressure ranges from 4 to 7,500 psi, and proof pressure to 12,000 psi
- Choice of seven electrical terminations
- NPT or SAE threaded pressure connections



**117 Series**

- Single Switch for Corrosive and Hazardous Division 2 Locations
- Compact pressure, differential pressure and temperature models
- Hermetically-sealed SPDT and DPDT output
- Epoxy-coated weather-tight design houses stainless steel internal construction
- Convenient terminal block wiring



**400 Series**

- 1, 2, and 3 switch output may be separated up to 100% of range
- Wide selection of pressure, differential pressure, and temperature ranges
- Setting via reference dial or hex screw adjustment
- Weathertight 4X design ideal for ordinary location applications



**Temperature Sensors**

Rugged RTDs and thermocouples for process and energy applications, available with Nema 4X and explosion-proof heads to match heat-trace, turbine, combustion, and stack-emission applications



## RECOMMENDED PRACTICES AND WARNINGS

United Electric Controls Company recommends careful consideration of the following factors when specifying and installing UE pressure and temperature units. Before installing a unit, the Installation and Maintenance instructions provided with unit must be read and understood.

- To avoid damaging unit, proof pressure and maximum temperature limits stated in literature and on nameplates must never be exceeded, even by surges in the system. Operation of the unit up to maximum pressure or temperature is acceptable on a limited basis (e.g., start-up, testing) but continuous operation must be restricted to the designated over range pressure. Excessive cycling at maximum pressure or temperature limits could reduce sensor life.
- A back-up unit is necessary for applications where damage to a primary unit could endanger life, limb or property. A high or low limit switch is necessary for applications where a dangerous runaway condition could result.
- The adjustable range must be selected so that incorrect, inadvertent or malicious setting at any range point cannot result in an unsafe system condition.
- Install unit where shock, vibration and ambient temperature fluctuations will not damage unit or affect operation. When applicable, orient unit so that moisture does not enter the enclosure via the electrical connection. When appropriate, this entry point should be sealed to prevent moisture entry.
- Unit must not be altered or modified after shipment. Consult UE if modification is necessary.
- Monitor operation to observe warning signs of possible damage to unit, such as drift in set point or faulty display. Check unit immediately.
- Preventative maintenance and periodic testing is necessary for critical applications where damage could endanger property or personnel.
- Electrical ratings stated in literature and on nameplate must not be exceeded. Overload on a switch can cause damage, even on the first cycle. Wire unit according to local and national electrical codes, using wire size recommended in installation sheet.
- Do not mount unit in ambient temp. exceeding published limits.

## LIMITED WARRANTY

Seller warrants that the product hereby purchased is, upon delivery, free from defects in material and workmanship and that any such product which is found to be defective in such workmanship or material will be repaired or replaced by Seller (Ex-works, Factory, Watertown, Massachusetts. INCOTERMS); provided, however, that this warranty applies only to equipment found to be so defective within a period of 24 months from the date of manufacture by the Seller. Seller shall not be obligated under this warranty for alleged defects which examination discloses are due to tampering, misuse, neglect, improper storage, and in any case where products are disassembled by anyone other than authorized Seller's representatives. EXCEPT FOR THE LIMITED WARRANTY OF REPAIR AND REPLACEMENT STATED ABOVE, SELLER DISCLAIMS ALL WARRANTIES WHATSOEVER WITH RESPECT TO THE PRODUCT, INCLUDING ALL IMPLIED WARRANTIES OF MERCHANTABILITY OR FITNESS FOR ANY PARTICULAR PURPOSE.

## LIMITATION OF SELLER'S LIABILITY

SELLER'S LIABILITY TO BUYER FOR ANY LOSS OR CLAIM, INCLUDING LIABILITY INCURRED IN CONNECTION WITH (I) BREACH OF ANY WARRANTY WHATSOEVER, EXPRESSED OR IMPLIED, (II) A BREACH OF CONTRACT, (III) A NEGLIGENT ACT OR ACTS (OR NEGLIGENT FAILURE TO ACT) COMMITTED BY SELLER, OR (IV) AN ACT FOR WHICH STRICT LIABILITY WILL BE INPUTTED TO SELLER, IS LIMITED TO THE "LIMITED WARRANTY" OF REPAIR AND/OR REPLACEMENT AS SO STATED IN OUR WARRANTY OF PRODUCT. IN NO EVENT SHALL THE SELLER BE LIABLE FOR ANY SPECIAL, INDIRECT, CONSEQUENTIAL OR OTHER DAMAGES OF A LIKE GENERAL NATURE, INCLUDING, WITHOUT LIMITATION, LOSS OF PROFITS OR PRODUCTION, OR LOSS OR EXPENSES OF ANY NATURE INCURRED BY THE BUYER OR ANY THIRD PARTY.

*UE specifications subject to change without notice.*

Be sure to visit [www.ueonline.com](http://www.ueonline.com) for the latest information.

**INSTRUMENTS • CONTROLS • VALVES**  
[CLICK TO VISIT OUR WEBSITE](http://www.ueonline.com)  
**3317 Gilmore Industrial Blvd.  
Louisville, KY 40213**  
**Ph: (502) 966-3134  
Fx: (502) 966-3135**  
[www.arcoengineering.com](http://www.arcoengineering.com)

**U.S.**  
United Electric Controls  
3101 Hamlet Road  
Phone: 815-341-2588  
email: [midwestsales@ueonline.com](mailto:midwestsales@ueonline.com)

United Electric Controls  
28 N. Wise Ave.  
Freeport, IL 61032  
Phone: 815-341-2588  
email: [midwestsales@ueonline.com](mailto:midwestsales@ueonline.com)

United Electric Controls  
1022 Vineyard Drive  
Conyers, GA 30013  
Phone: 770-335-9802  
email: [southeastsales@ueonline.com](mailto:southeastsales@ueonline.com)

United Electric Controls  
5829 Grazing Court  
Mason, OH 45040  
Phone: 513-535-5486  
email: [midatlanticsales@ueonline.com](mailto:midatlanticsales@ueonline.com)

United Electric Controls  
102 Salazar Court  
Clayton, CA 94517  
Phone: 925-408-5997  
email: [westcoastsales@ueonline.com](mailto:westcoastsales@ueonline.com)

United Electric Controls  
27 Summit Terrace  
Sparta, NJ 07871  
Phone: 973-271-2550  
email: [easternsales@ueonline.com](mailto:easternsales@ueonline.com)

United Electric Controls  
33018 Weatherby Court  
Fulshear, Texas 77441  
Phone: 832-457-6138  
email: [southwestsales@ueonline.com](mailto:southwestsales@ueonline.com)

**EUROPE**  
United Electric Controls  
05-806 Komorow  
Kujawska 5, Poland  
Phone: +48 22 499 4804  
email: [easterneuropesales@ueonline.com](mailto:easterneuropesales@ueonline.com)

**INDIA**  
#402, Aries Avenue - 1  
United Colony, Sama  
Baroda (Gujarat), India 390 008  
Phone: +91 (-265) -2788654  
email: [indiasales@ueonline.com](mailto:indiasales@ueonline.com)

**ASIA-PACIFIC**  
United Electric Controls, Far East  
No. 1-2-2, 2nd Floor  
Jalan 4/101C  
Cheras Business Centre  
Batu 5, Jalan Cheras  
56100 Kuala Lumpur, Malaysia  
Phone: 603-9133-4122  
email: [fareastsales@ueonline.com](mailto:fareastsales@ueonline.com)

**MEXICO - LATIN AMERICA**  
United Electric Controls  
Zacatecas # 206, Suite 20  
Col Guadalupe CP 89120  
Tampico, Tamaulipas Mexico  
Phone: 833-217-5201  
email: [latinamericasales@ueonline.com](mailto:latinamericasales@ueonline.com)

**CANADA**  
**EASTERN**  
68 Mosley Crescent  
Brampton, Ontario  
Canada L6Y 5C8  
Phone: 905-455-5131  
FAX: 905-455-5131

**RUSSIA & NORTHERN EUROPE**  
United Electric Controls, Moscow  
Elninskaya str., 15-140  
Moscow, 121552, Russia  
Phone: +7 (495) 792-88-06  
email: [russiansales@ueonline.com](mailto:russiansales@ueonline.com)

**Shanghai Office**  
Building  
, Luwan District  
China  
Phone: +8621-6255 8059  
email: [chinasales@ueonline.com](mailto:chinasales@ueonline.com)

United Electric Controls, *Beijing Office*  
Room 1006, Jainhao International Bldg.  
Block D, No. 116  
Zizhuyuanlu, Haidian District  
Beijing, China 100089  
Phone: +86-10-5893-0518  
email: [beijingsales@ueonline.com](mailto:beijingsales@ueonline.com)

 **UNITED ELECTRIC  
CONTROLS**

180 Dexter Avenue, P.O. Box 9143  
Watertown, MA 02471-9143 USA  
Telephone: 617 926-1000 Fax: 617 926-2568  
<http://www.ueonline.com>

CP07112500